

Mentorium 3
Business Informatics 2 (PWIN)

Communication Systems I & II

SS 2023

Frédéric Tronnier
www.m-chair.de

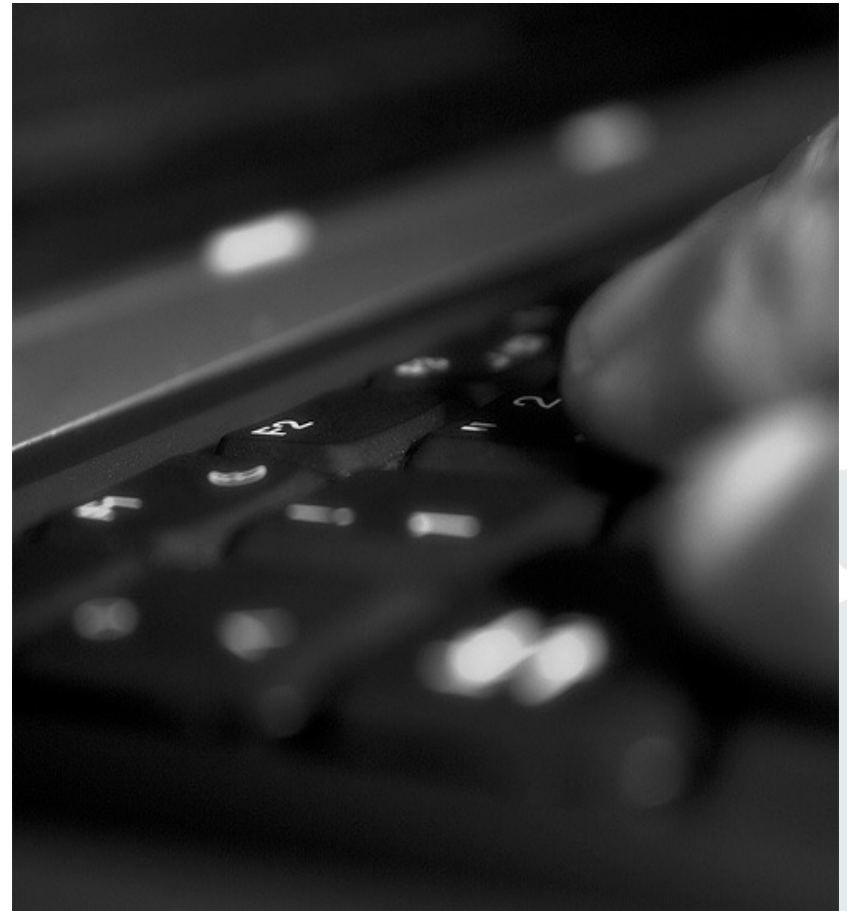

Jenser (Flickr.com)

- Exercise 1: OSI reference model
- Exercise 2: Fixed Networks
- Exercise 3: Wireless Local Area Networks
- Exercise 4: Bluetooth and NFC

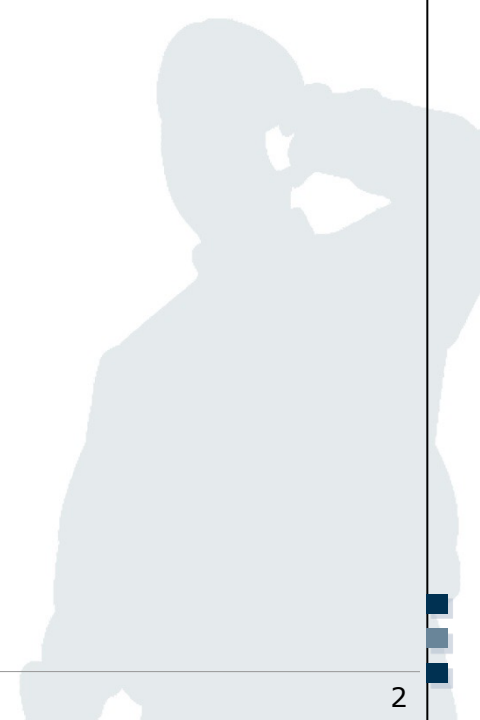

- In which layer are TCP and UDP used? What is the main difference between them?
- Please describe the three way handshake (TCP).
- Should myPlace use TCP or UDP? Why?

- The following graph shows the various systems a message from a place of interest needs to pass to get to the end user of myPlace. Please calculate the fastest track. Note that lower case letters denote *system vertices* and the numbers the *bandwidth* of a connection.

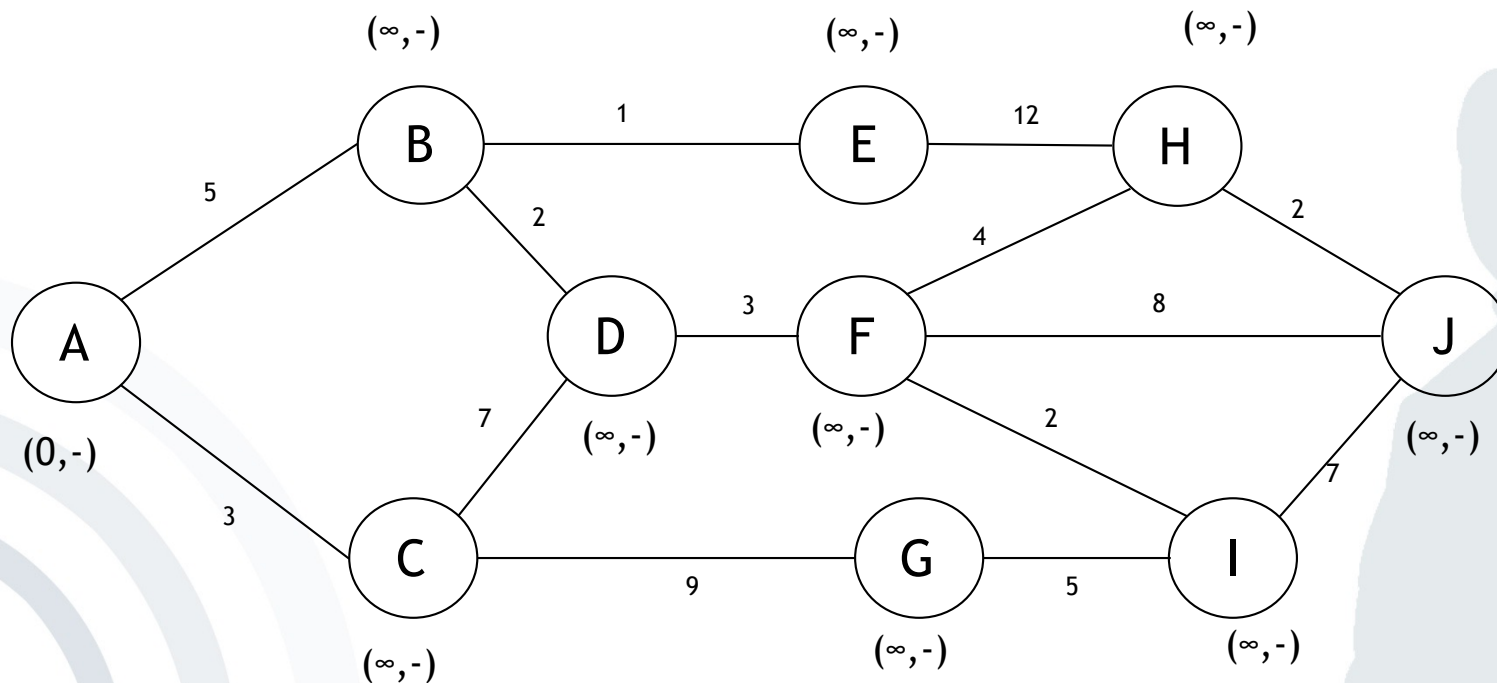

- What is IPv6 and why do we need it? According to the ISO/OSI model, in which layer is the IP protocol?
- Should myPlace integrate IPv6? Why or why not? What does IPv6 mean with regard to user privacy?

- What is the difference between an IP and a MAC address?

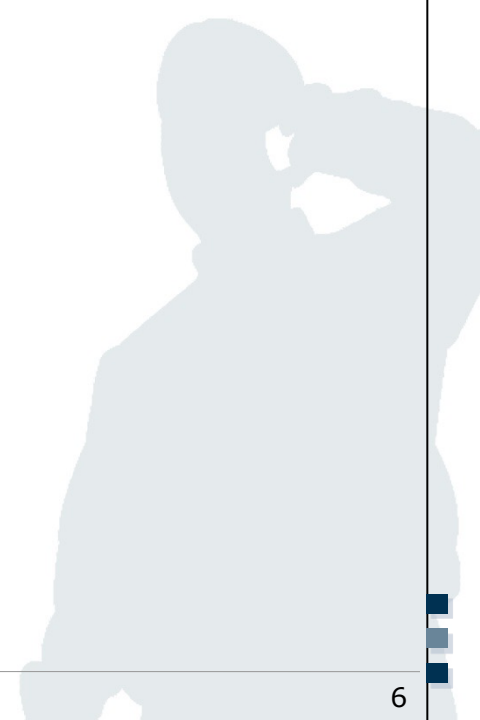

- Exercise 1: OSI reference model
- Exercise 2: Fixed Networks
- Exercise 3: Wireless Local Area Networks
- Exercise 4: Bluetooth and NFC

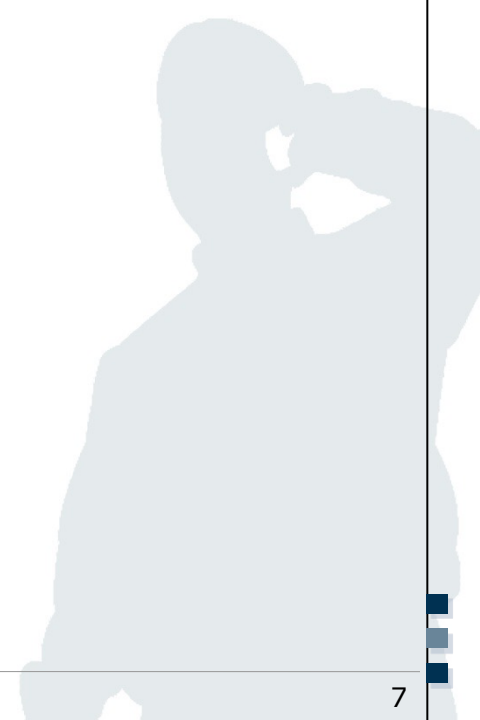

- What are the main challenges in wired communication and why?

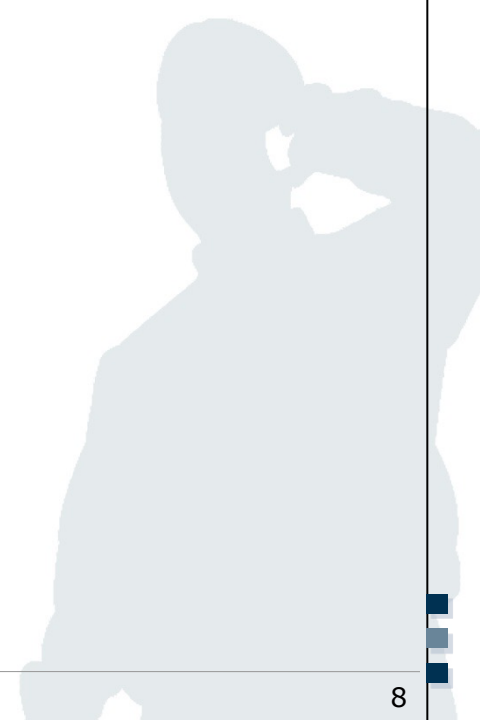

- Name three different types of topologies and expose their advantages and disadvantages.

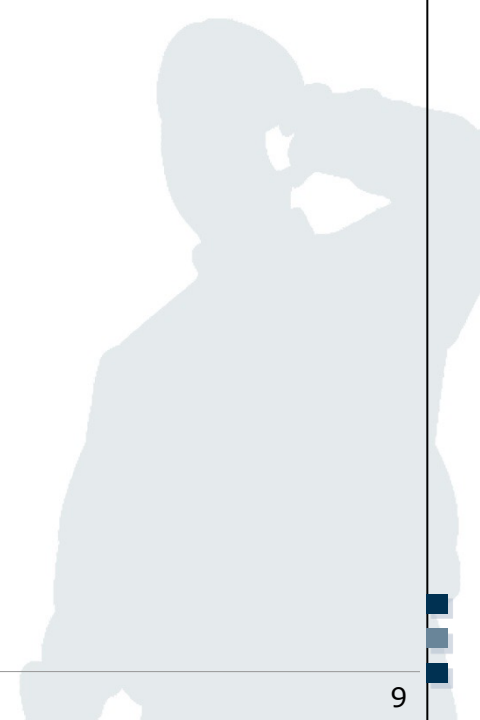

- Exercise 1: OSI reference model
- Exercise 2: Fixed Networks
- Exercise 3: Wireless Local Area Networks
- Exercise 4: Bluetooth and NFC

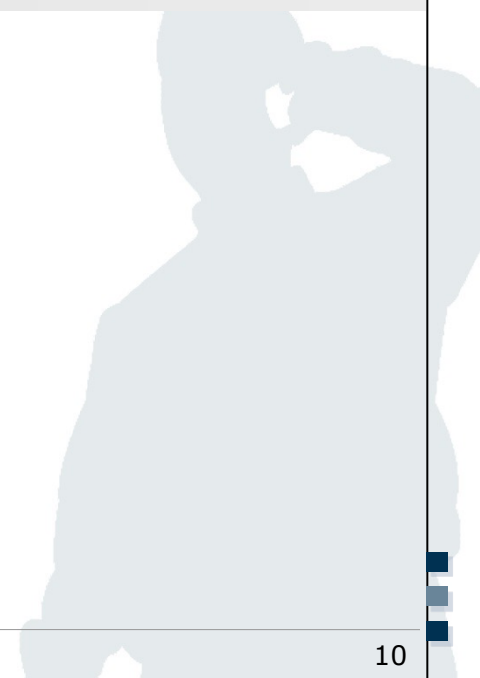

- Name a secure method for the encryption of Wireless Local Area Networks (Wi-Fi).
- Why is Wi-Fi encryption important? What could be the potential consequences for users failing to enable encryption for their Wi-Fi network?

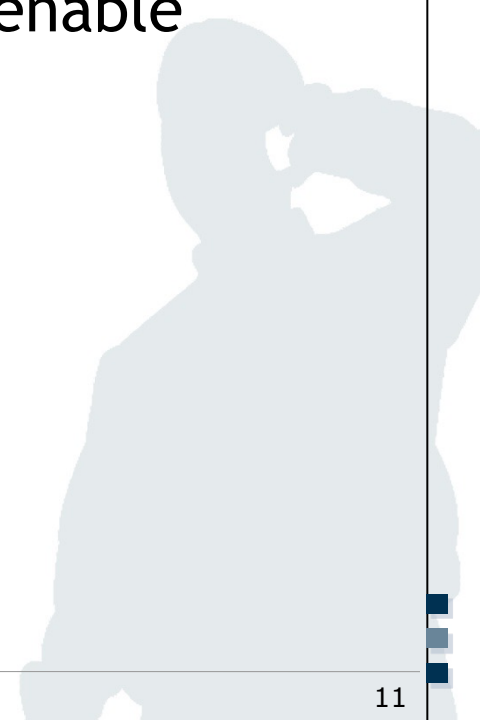

- What could be the potential harm if the data communication of the myPlace service is not encrypted?

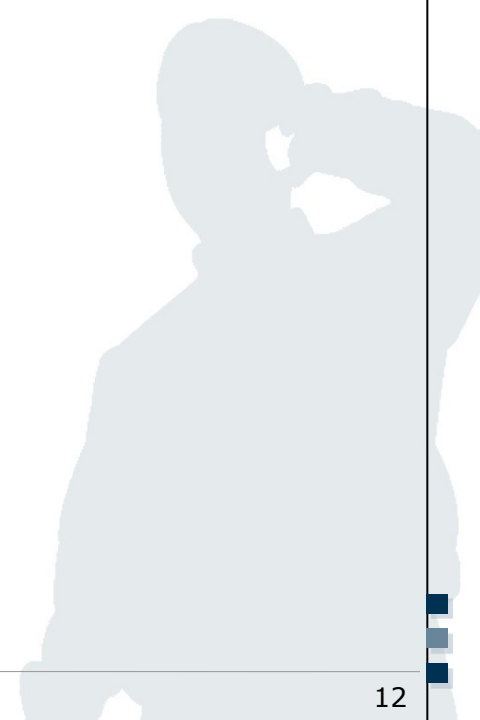

- Exercise 1: OSI reference model
- Exercise 2: Fixed Networks
- Exercise 3: Wireless Local Area Networks
- Exercise 4: Bluetooth and NFC

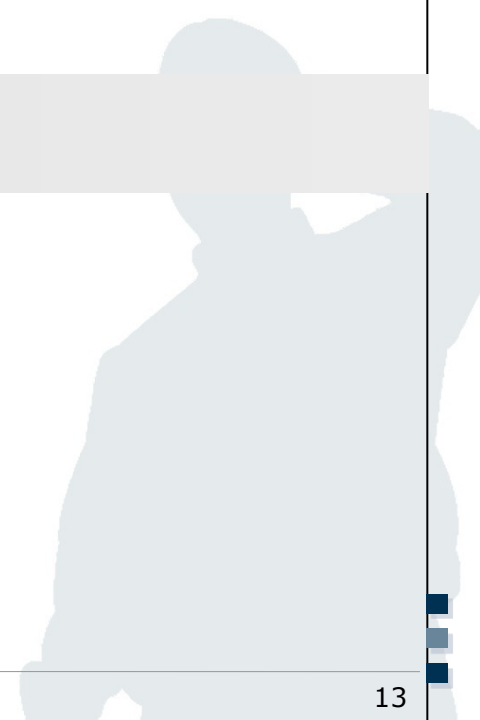

What is Bluetooth and what is NFC? Where is the difference between them?

